

# Dalton



	Seat - Assise	Backrests - Dossiers	Structure - Structure	
<b>Upholstering</b> <i>Revetement</i> (10)	Removable <i>Déhoussable</i>			
	Not removable <i>Non déhoussable</i>	—	—	
<b>Padding</b> <i>Rembourrages</i> (2-4-5-6-7-8)	+	+	+	
	D.35/40kg/m³	D.18kg/m³	Polyurethane foam	optional

## TECHNICAL INFORMATION

### Structure: 1-3

Supporting structure in class E1 plywood panels and supporting solid fir wood of differing thicknesses, buffers in class E1 particleboard panels.

### Springing: 1-11

The back is supported by propylene and latex elastic belts. Seat in class E1 plywood panels.

### Note:

With UP feet the whole sofa or composition can be raised 5 cm compared to the dimensions shown.

## INFORMATIONS TECHNIQUES

### Structure: 1-3

Châssis en panneaux de contreplaqués de classe E1 et supports massifs en épicéa de différentes épaisseurs, compensations en panneaux de fibres de bois de classe E1.

### Suspension: 1-11

Dossier avec sangles élastiques de fibre propylénique et latex. Assise en panneaux de contreplaqué de classe E1.

### Note:

Avec les pieds UP tout le canapé ou composition peut être rehaussé de 5 cm par rapport aux dimensions reportées.

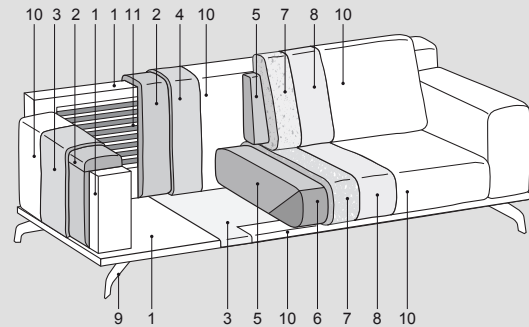
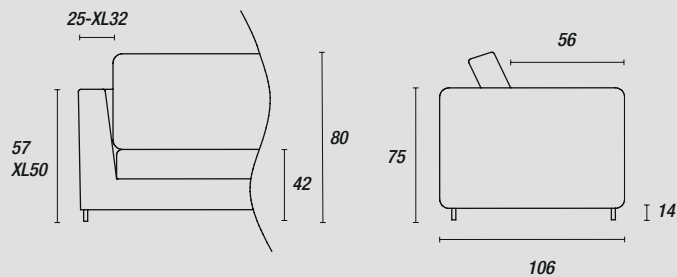







### Feet - Pieds::

 H.14cm	 H.14cm	 H.14-19cm
Black (ME09)	at a surcharge Shining Chromium (ME04) Black Chrome (ME05)	Black (ME09) Light brown (ME11)

# Dalton soft



	Seat - Assise	Backrests - Dossiers	Structure - Structure	
<b>Upholstering</b> <i>Revetement</i> (10)	Removable <i>Déhoussable</i>			
	Not removable <i>Non déhoussable</i>	-	-	-
<b>Padding</b> <i>Rembourrages</i> (2-4-5-6-7-8)	 D.35/40kg/m³	 Mixed feather	 Polyurethane foam	 optional

## TECHNICAL INFORMATION

### Structure: 1-3

Supporting structure in class E1 plywood panels and supporting solid fir wood of differing thicknesses, buffers in class E1 particleboard panels.

### Springing: 1-11

The back is supported by propylene and latex elastic belts. Seat in class E1 plywood panels.

### Note:

With UP feet the whole sofa or composition can be raised 5 cm compared to the dimensions shown.

## INFORMATIONS TECHNIQUES

### Structure: 1-3

Châssis en panneaux de contreplaqués de classe E1 et supports massifs en épicea de différentes épaisseurs, compensations en panneaux de fibres de bois de classe E1.

### Suspension: 1-11



Dossier avec sangles élastiques de fibre propylénique et latex. Assise en panneaux de contreplaqué de classe E1.

### Note:

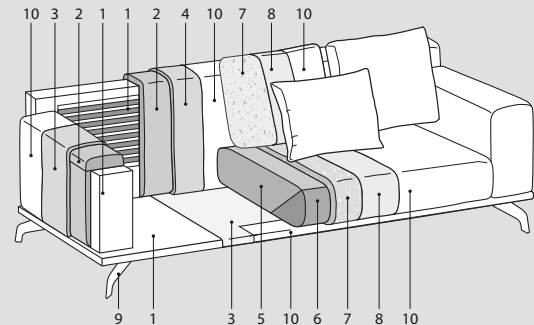
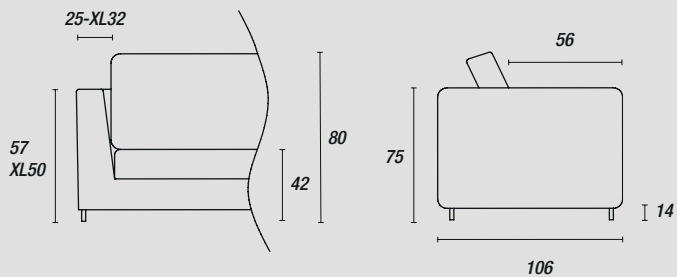
Avec les pieds UP tout le canapé ou composition peut être rehaussé de 5 cm par rapport aux dimensions reportées.

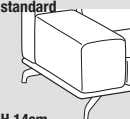
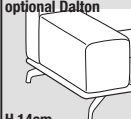

### Feet - Pieds::

 H.14cm Black (ME09)	 H.14cm at a surcharge Shining Chromium (ME04) Black Chrome (ME05)	 H.14-19cm Black (ME09) Light brown (ME11)
---	---	--