

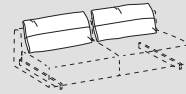



 Struttura - Structure	 Schienali - Backrests	
<b>Rivestimento Upholstering (12)</b>	Sfoderabile Removable 	Sfoderabile Removable  	
	Non sfoderabile Not removable 	—	
<b>Imbottiture Padding (5-6-7-8-9-10-11)</b>	 D.21-25-35-40-45kg/m³	 Misto piuma	

## INFORMAZIONI TECNICHE

### Struttura: (1-2-3)

Masselli portanti in legno di abete. Elementi strutturali in pannelli di legno multistrati in classe E1, tamponamenti in faesite.

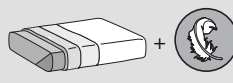
### Molleggio: (3-4)

Schienale in pannello di faesite. Seduta in nastri elastici di fibra propilenica e lattice incrociati e meccanicamente pretensionati.

### Note:

Bracciolo a tavolino con piano (14) in pannello di particelle di legno (MDF) classe E1 impiallacciato verniciato finitura Grey wood (LE12) e struttura in metallo verniciato (ME11) Light brown (15).

### Insero schienale in tessuto Tallin o Malaga.

Rivestimento non disponibile nei seguenti tessuti: Like, Lolita, Manhattan, Uber. Piedi (13) in legno massiccio di frassino.

## TECHNICAL INFORMATION

### Structure: (1-2-3)

Solid fir wood. Structural elements in multilayer wood panels in class E1, infills in faesite.

### Springing: (3-4)

The back is made of hardboard panels.

Seat with pre-tensioned crossed propylene fibre and latex elastic webbing.

### Note:

Table armrest with top (14) made of class E1 veneered wood particle board (MDF) with Grey wood finish (LE12) and painted metal frame (ME11) Light brown (15).

### Backrest insert in Tallin or Malaga fabric.

Upholstery not available in the following fabrics: Like, Lolita, Manhattan, Uber. Feet (13) in solid ash wood.

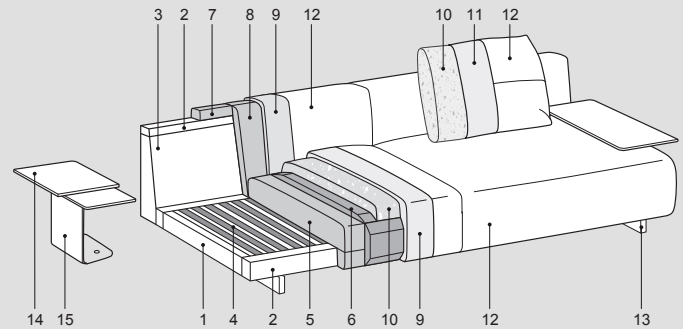
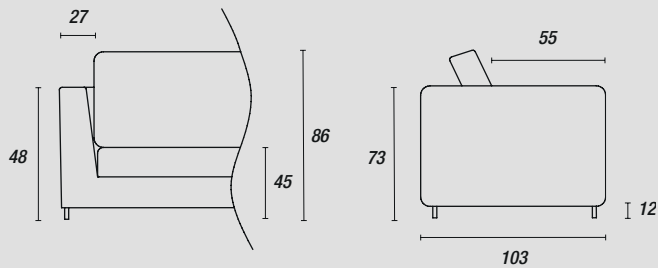

### Piedini - Feet:

#### di serie



Grey wood (LE12)

#### opzionale a slitta

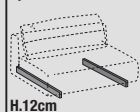

Grey wood (LE12)

### Accessori - Accessories:

#### Bracciolo

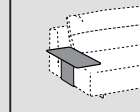

Grey wood (LE12)  
e  
Light brown (ME11)